

Front Suspension:

Ride Height: _____

Camber: _____

Toe: _____

Anti-Roll Bar

Size: _____

Gap: _____

Ackerman

1
2
3
4
5

Notes:

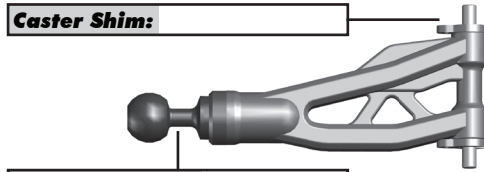
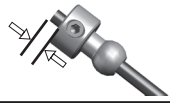

Upper Ball Type: _____

Upper Ball Shim: _____

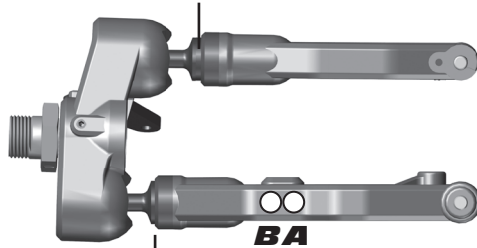

Lower Ball Shim: _____

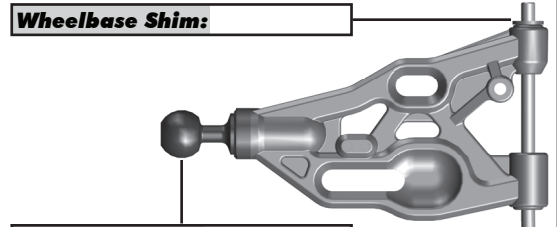

Lower Ball Type: _____

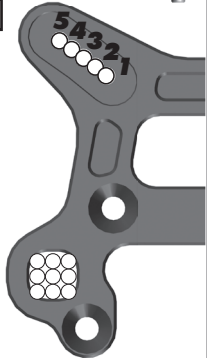

Rear Suspension:

Ride Height: _____

Camber: _____

Anti-Roll Bar

Size: _____

Gap: _____

Notes:

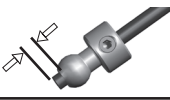

Hub Shim: _____

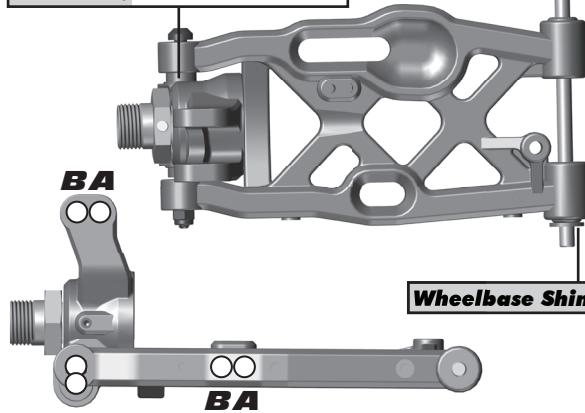

Wheelbase Shim: _____

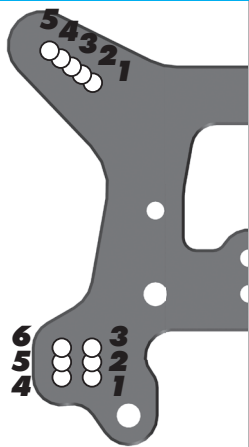

Electronics and Engine:

Radio: _____

Receiver Battery: _____

Throttle Servo: _____

Steering Servo: _____

EPA: Throttle: _____ % Brake: _____ %

Brake Bias: _____ **D/R:** _____ %

Engine: _____ **Temp:** _____

Muffler: _____ **Fuel:** _____

Restrictor: _____ **Glow Plug:** _____

Differential Fluid:

Front: _____

Center: _____

Rear: _____

Notes: _____

Clutch and Gearing:

Spur Gear: _____ **Bell:** _____

Shoes: _____

Springs: _____

Notes: _____

Shocks:

	Front	Rear
Piston:	_____	_____
Fluid:	_____	_____
Spring:	_____	_____
Stroke:	_____	_____
Free Length:	_____	_____
Notes:	_____	

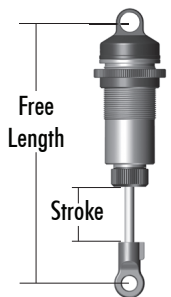

Track Info:

Size: Small Medium Large Extra Large

Surface: Dirt Carpet Astroturf Multi Surface

Traction: Low Medium High Very High

Moisture: Dry Damp Wet

Condition: Indoor Outdoor Dusty Hard Packed
 Bumpy Grooved Smooth Loamy

Temperature: Ambient: _____ Track: _____

Notes: _____

Tires:

Front Tires: _____

Front Compound: _____

Front Insert: _____

Rear Tires: _____

Rear Compound: _____

Rear Insert: _____

Wheel (F/R): _____

Notes: _____

Body, Wings:

Body: _____

Wing: _____

Wing Height: High: Low:

Gap to Tower: _____

Weight:

Total Vehicle Weight: _____

Notes: _____

Vehicle Comments:

Notes: _____